

REFERENCE

SPEC No. DG-072002

SHARP

ISSUE

Feb-6-07

COMPOUND SEMICONDUCTOR SYSTEMS DIVISION

ELECTRONIC COMPONENTS(ELECOM) GROUP

SHARP CORPORATION

TECHNICAL LITERATURE

DEVICE SPECIFICATION FOR
LIGHT EMITTING DIODE

MODEL No. **GM4WA25300A**

CUSTOMERS' APPROVAL

Date _____

By _____

PRESENTED

Date *Feb. - 6 - 07*

By *S. Yokota*

S. Yokota
Department General Manager
LED Business Development Center
Compound Semiconductor Systems Division
Electronic Components (Elecom) Group
SHARP CORPORATION

※This technical literature is subject to change or revise without notice, since this is the developing product.

PRODUCT NAME	Light Emitting Diode
MODEL No.	GM4WA25300A

1. These technical literature sheets include materials protected under the copyright of Sharp Corporation ("Sharp"). Please do not reproduce or cause anyone to reproduce them without Sharp's consent.
2. When using this product, please observe the absolute maximum ratings and the instructions for use outlined in these technical literature sheets, as well as the precautions mentioned below. Sharp assumes no responsibility for any damage resulting from use of the product which does not comply with the absolute maximum ratings and the instructions included in these technical literature sheets, and the precautions mentioned below.

(Precautions)

(1) This products is designed for use in the following application areas;

- | | |
|--|---|
| <ul style="list-style-type: none"> * OA equipment * Audio visual equipment * Home appliance * Telecommunication equipment (Terminal) * Measuring equipment * Tooling machines * Computers | } |
|--|---|

If the use of the product in the above application areas is for equipment listed in paragraphs (2) or (3), please be sure to observe the precautions given in those respective paragraphs.

(2) Appropriate measures, such as fail-safe design and redundant design considering the safety design of the overall system and equipment, should be taken to ensure reliability and safety when this product is used for equipment which demands high reliability and safety in function and precision, such as ;

- | | |
|---|---|
| <ul style="list-style-type: none"> * Transportation control and safety equipment (aircraft, train, automobile etc.) * Traffic signals * Gas leakage sensor breakers * Rescue and security equipment * Other safety equipment | } |
|---|---|

(3) Please do not use this product for equipment which require extremely high reliability and safety in function and precision, such as ;

- | | |
|--|---|
| <ul style="list-style-type: none"> * Space equipment * Telecommunication equipment (for trunk lines) * Nuclear power control equipment * Medical equipment | } |
|--|---|

(4) Please contact and consult with a Sharp sales representative if there are any questions regarding interpretation of the above three paragraphs.

3. Please contact and consult with a Sharp sales representative for any questions about this product.

SHARP

GM4WA25300A Technical Literature

1. Application

This technical literature applies to the outlines and characteristics of the light emitting diode device Model No. GM4WA25300A. [AlGaInP red chip LED, InGaN green and blue chip LED device]
This product is designed for various kinds of common indication devices.

2. Outline dimensions and terminal connections ----- Refer to Page 3.

3. Ratings and characteristics ----- Refer to Page 4 ~ 8.

- 3-1. Absolute maximum ratings
- 3-2. Electro-optical characteristics
- 3-3. Derating Curve
- 3-4. Characteristics Diagram

4. Reliability ----- Refer to Page 9.

- 4-1. Test items and test conditions
- 4-2. Measurement items and failure judgment criteria

5. Quality level ----- Refer to Page 10.

- 5-1. Applied standard
- 5-2. Sampling method
- 5-3. Test items, Defect judgment criteria and classification of defect

6. Supplements ----- Refer to Page 11 ~ 14.

- 6-1. Taping
- 6-2. Packing Specification
- 6-3. Label
- 6-4. Chromaticity rank
- 6-5. Environment

7. Precautions for use ----- Refer to Page 15 ~ 17.

- 7-1. General description for use
- 7-2. Soldering conditions
- 7-3. For cleaning

SHARP

2. Outline dimensions and terminal connections

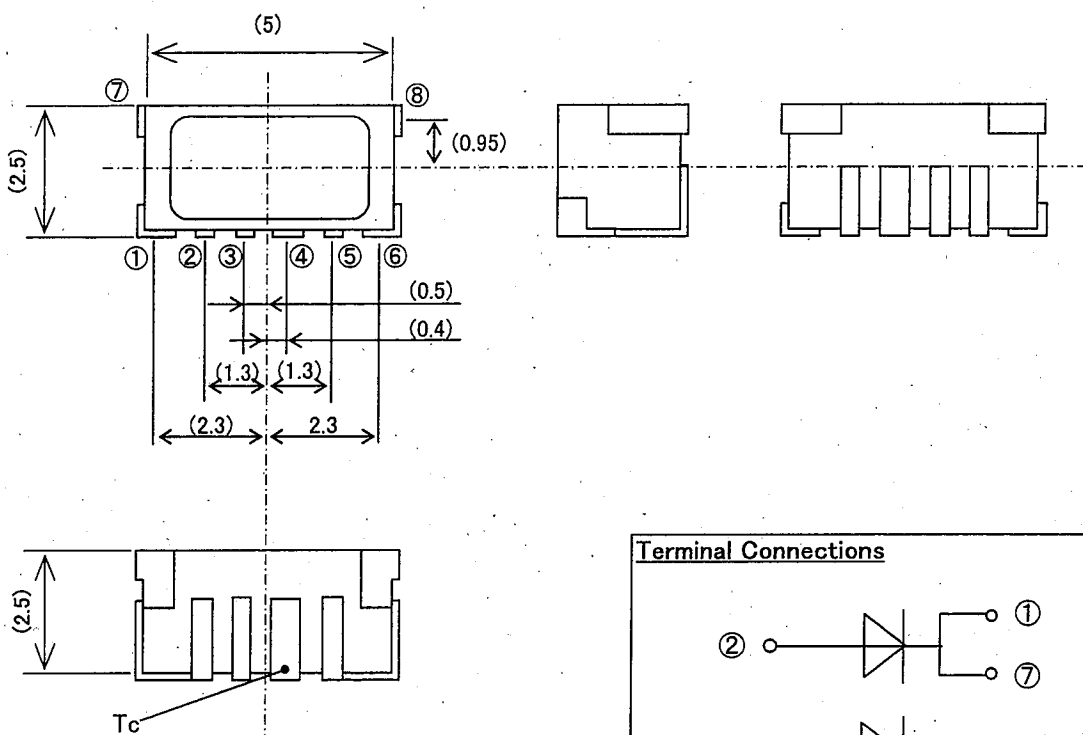

Terminal Connections

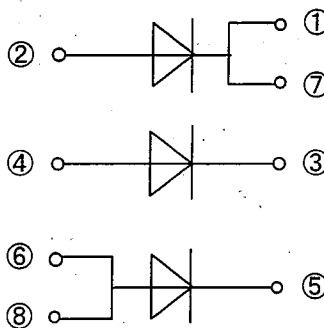

Notes.

- Terminal Connections ① Red Cathode ② Red Anode ③ Green Cathode ④ Green Anode ⑤ Blue Cathode ⑥ Blue Anode
⑦ Red Cathode ⑧ Blue Anode
- Unspecified tolerance to be ± 0.3
- Dimensions in parenthesis are reference values.
- Tc: (Case Temperature) Measurement value to be the maximum temperature of the four cathode terminals.

unit	Material	Finish	Drawing No.
mm	Frame: Copper alloy Package: Nylon + Silicone resin	Frame: Ag plated	51902002

SHARP

3. Ratings and characteristics

3-1. Absolute maximum ratings

(Tc=25 °C)

Parameter	Symbol	Rating			Unit
		Red	Green	Blue	
Power dissipation	P	300			mW
Continuous forward current(*1)	I _F	30	30	30	mA
Peak forward current(*2)	I _{FM}	100	100	100	mA
Derating factor	DC	0.86	0.86	0.86	mA/°C
	Pulse	2.86	2.86	2.86	mA/°C
Reverse voltage	V _R	5	5	5	V
Operating temperature(*3)	Tc(*3)	-30 to +85(*5)			°C
Storage temperature(*3)	Tstg	-40 to +85			°C
Soldering temperature(*4)	Tsol	295			°C

(*1) Rating is prescribed by each color chip. In operating three color chips simultaneously, be sure not to exceed the rating of power dissipation.

(*2) Duty ratio $\leq 1/10$, Pulse width ≤ 0.1 ms

(*3) Case temperature(See page 3/17 2.outline dimensions and terminal connections)

(*4) Each terminal must be soldered with the soldering iron of capacity 30W within 3 seconds under 295°C.

(*5) The operation current value follows the derating curve. (See page 5/17 3-3 Derating curve)

3-2. Electro-optical characteristics

(Tc=25 °C)

Parameter	Symbol	Condition	MIN.	TYP.	MAX.	Unit
Forward Voltage	Red	I _F =20 mA	(1.7)	2.3	(2.6)	V
	Green		(2.8)	3.3	(3.9)	
	Blue		(2.8)	3.3	(3.7)	
Luminous intensity (mixed color) (*6)	I _V	Red: I _F =(21)mA	-	2000	-	mcd
chromaticity (mixed color) (*7)	The area enclosed by 4 points of color coordinates	region	Green: I _F =(25)mA	x	y	
		point 1		0.250	0.337	
		point 2	Blue: I _F =(7)mA	0.350	0.363	
		point 3		0.250	0.237	
		point 4		0.350	0.263	
Reverse Current	Red	V _R =4V	-	-	100	μA
	Green		-	-	100	
	Blue		-	-	100	

(*6) Measured by EG&G MODEL550(Radiometer/Photometersystem).

(Tolerance : ±15%)

(*7) Measured by Ohtsuka electronics MODEL MCPD-2000 .

Chromaticity ranks are classified under the conditions shown above table, and they are not guaranteed values.

(Tolerance : x,y: ±0.02)

See page 14/17 6-4-1 chromaticity rank table.



3-3. Derating Curve

*The graphs of 'forward current derating curve', 'Peak forward current derating curve' and 'Peak forward current vs. duty ratio (Tc=25°C)' are applied to 1 chip-operation.

*Power dissipation derating curve is applied to 3 chip-operation. However, 'forward current derating curve' for 1 chip-operation is the prior limitation.

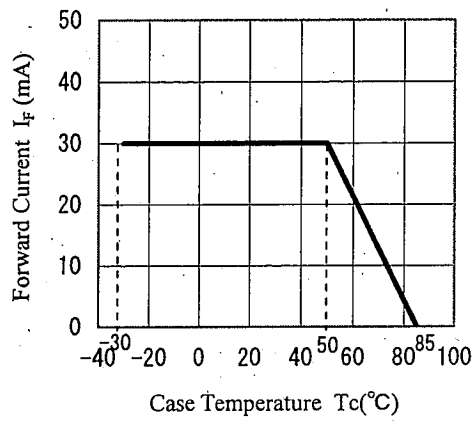

Forward Current Derating Curve

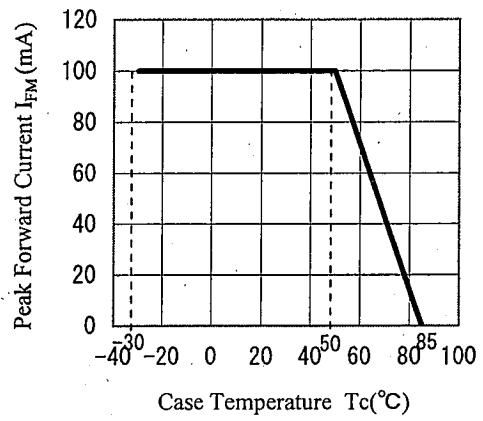

Peak Forward Current Derating Curve
Duty 1/10 pulse

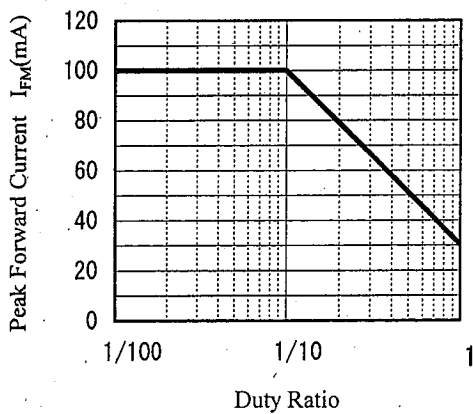

Peak Forward Current vs. Duty Ratio (Tc=25 °C)
Pulse width 0.1ms

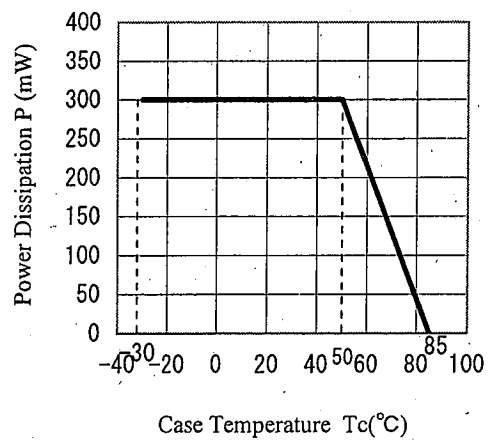

Power dissipation Derating Curve



3-4. Characteristics Diagram (TYP.)
 3-4-1. Characteristics of RED

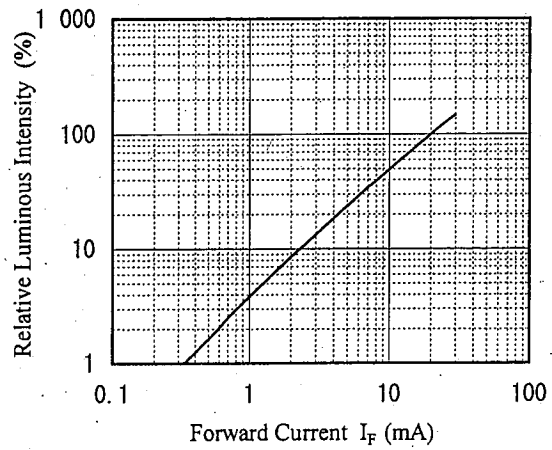

Relative Luminous Intensity vs. Forward Current ($T_c=25^\circ\text{C}$)

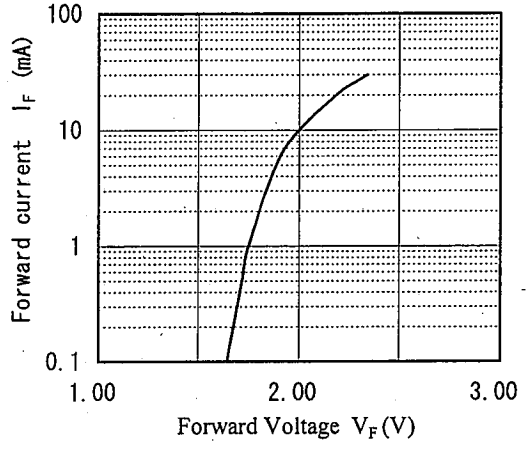

Forward Current vs. Forward Voltage ($T_c=25^\circ\text{C}$)

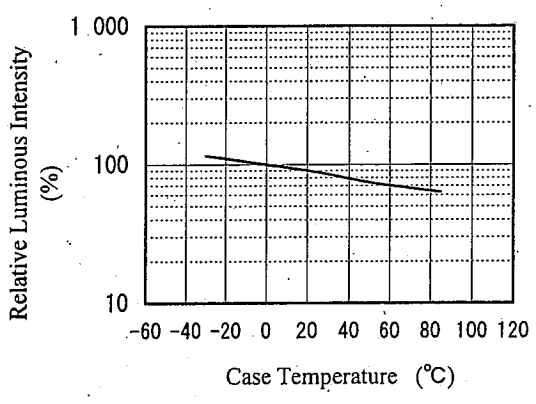

Relative Luminous Intensity vs. Case Temperature

(Note) Data shown here represent typical values and are for reference purpose only. (not guaranteed value)



3-4. Characteristics Diagram (TYP.)

3-4-2. Characteristics of GREEN

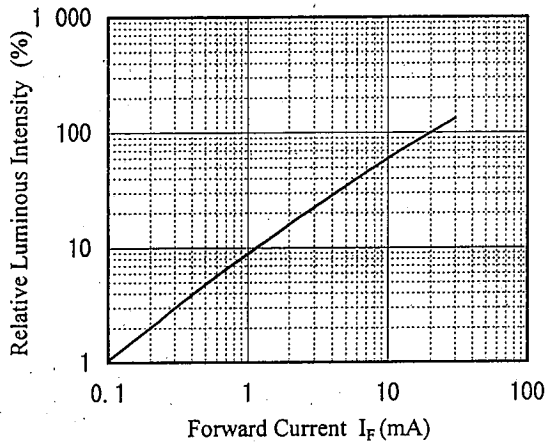

Relative Luminous Intensity vs. Forward Current (Tc=25 °C)

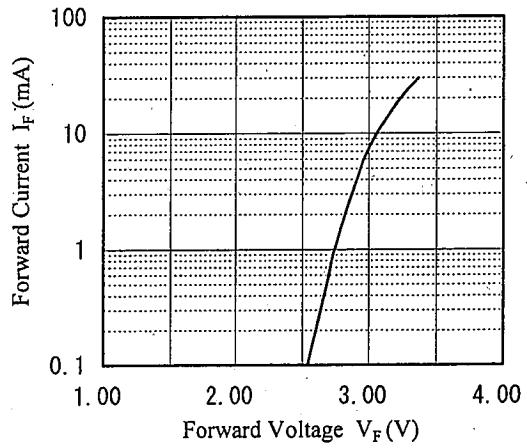

Forward Current vs. Forward Voltage (Tc=25 °C)

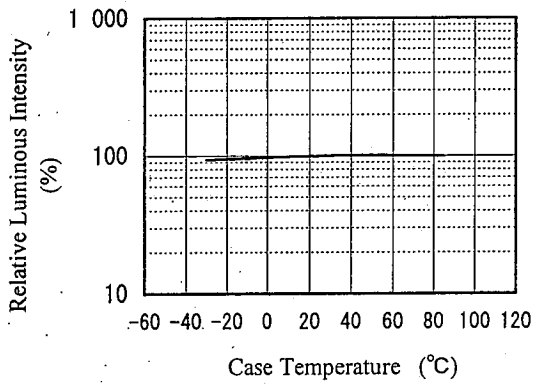

Relative Luminous Intensity vs. Case Temperature

(Note) Data shown here represent typical values and are for reference purpose only. (not guaranteed value)



3-4. Characteristics Diagram (TYP.)

3-4-3. Characteristics of BLUE

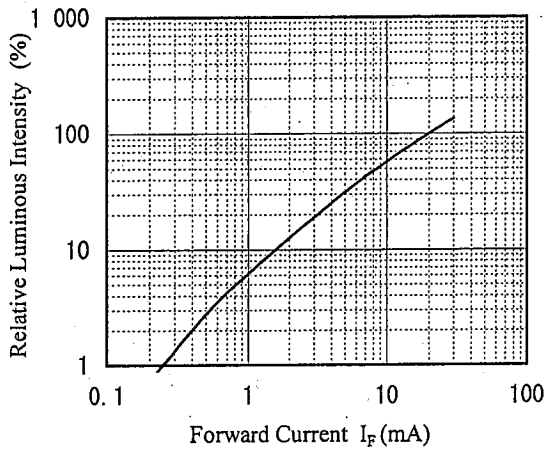

Relative Luminous Intensity vs. Forward Current ($T_c=25^\circ\text{C}$)

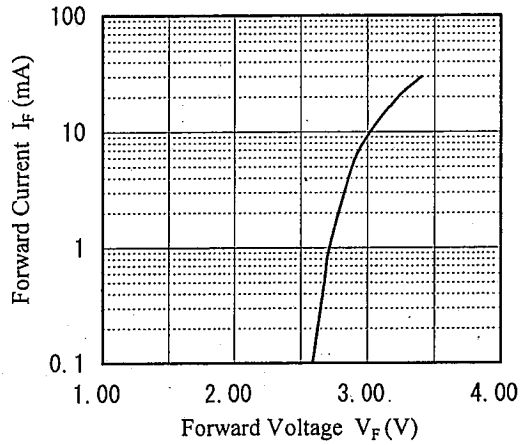

Forward Current vs. Forward Voltage ($T_c=25^\circ\text{C}$)

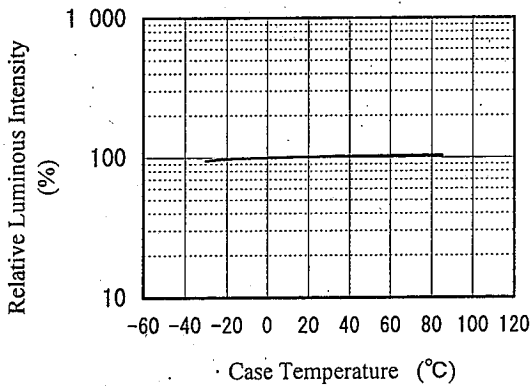

Relative Luminous Intensity vs. Case Temperature

(Note) Data shown here represent typical values and are for reference purpose only. (not guaranteed value)

SHARP

4. Reliability

The reliability of products shall be satisfied with items listed below.

4-1. Test items and test conditions

Confidence level: 90%

No.	Test items	Test conditions	Samples n	Defective C	LTPD (%)
1	Temperature cycle	-40 °C(30 min)~+85 °C(30 min),30 cycles	22	0	10
2	High temp and high humidity storage	Tstg=+60 °C, RH=90 %, t=1 000 h	22	0	10
3	High temperature storage	Tstg=+85°C, t=1 000 h	22	0	10
4	Low temperature storage	Tstg=-40°C, t=1 000 h	22	0	10
5	Operating test	Tc=+50 °C, I _F =30mA(each color), t=1 000 h [mixed color]	22	0	10
6	Mechanical shock	15 000 m/s ² , 0.5 ms ±X·±Y·±Z direction, 3 times (Tc=25°C)	11	0	20
7	Variable frequency vibration	200 m/s ² , 100~2 000~100 Hz / sweep for 4 min. X·Y·Z direction, 4 times (Tc=25°C)	11	0	20
8	Soldering temperature	Refer to the attached sheet, Page 14/15, Twice	11	0	20

4-2. Measurement items and failure judgment criteria (*1)

No.	items	Symbol	Failure judgment criteria (*2)
1	Forward voltage	V _F	V _F > U.S.L × 1.2
2	Reverse current.	I _R	I _R > U.S.L × 2.0
3	Luminous intensity(*3)	I _V	I _v < Initial value × 0.5, I _v > Initial value × 2.0

*1 : Measuring condition is in accordance with specification.

*2 : U.S.L. : Upper Specification Limit.

*3 : Mixed color

SHARP

5. Quality level

5-1. Applied standard
 ISO2859-1

5-2. Sampling method

A single sampling plan, normal inspection level S-4.

5-3. Test items, Defect judgment criteria and classification of defect.

No.	Test items	Defect judgment	Defect	AQL
1	No emission	No light emitting	Major defect	0.1 %
2	Radiation color	Different color against prescribed in the page 4/17.		
3	Taping	Product inserted in reverse direction		
4	Electro-optical characteristics	Not satisfied with specification value (page 4/17) for VF, IR, Iv.	Minor defect	0.4%
5	Outline dimenions	Not satisfied with specification value (page 3/17) for outline dimension.[A to D]		
6	Appearance	Foreign substances and flaws which affect the appearance. Resin burr which exceeds the dimension tolerance, 0.3mm MAX. More than 0.4mm of cracks in resin or terminal.		



6. Supplements

6-1. Taping

6-1-1. Shape and dimensions of tape (Reference value.)

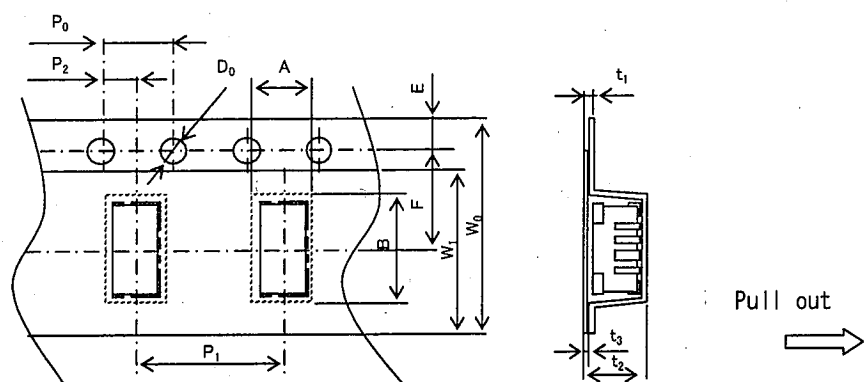

Parameter	Symbol	Dimension [mm] (Ref.)	Remarks
Concave square hole for part insertion	Vertical	A	2.85
	Horizontal	B	5.5
	Pitch	P_1	8.0
Round sprocket hole	Diameter	D_0	1.55
	Pitch	P_0	4.0
Center to center distance	Vertical	P_2	2.0
	Horizontal	F	5.65
Cover tape	Width	W_1	9.2
	Thickness	t_3	0.1
Carrier tape	Width	W_0	12.0
	Thickness	t_1	0.3
Thickness of entire unit	t_2	3.2	With cover tape and carrier tape combined

6-1-2. Shape and dimensions of reel (Reference value.)

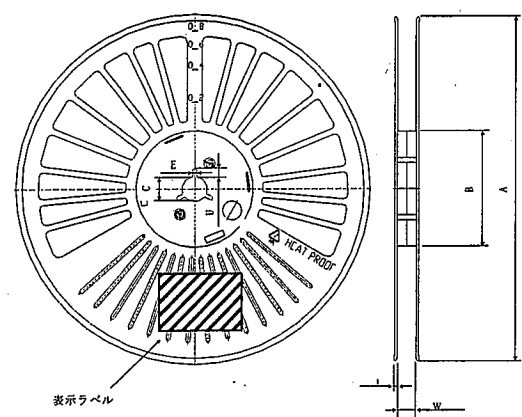

Parameter	Symbol	Dimension [mm] (Ref.)	Remarks	
Frange	Diameter	A	ϕ 180	
	Thickness	t	1.5	
	Inner space direction	W	13.5	Dimension of shaft core
Hub	External diameter	B	ϕ 60	
	Spindle hole diameter	C	ϕ 13	
	Key slit	Width	E	2.0
		Depth	U	4.5
Notation for part name etc.		Labeling on the side of the flange. (part name, quantity, lot No.)		

※Material: polystyrene

SHARP

6-1-3. Taping specification

(1) Lead tape:

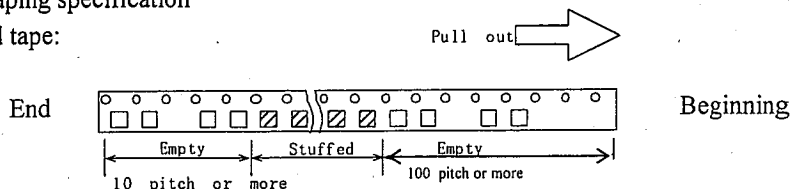

(2) Cover tape strength against peeling: $F=0.1\sim 1.2N$ ($\theta = 10^\circ$ or less)

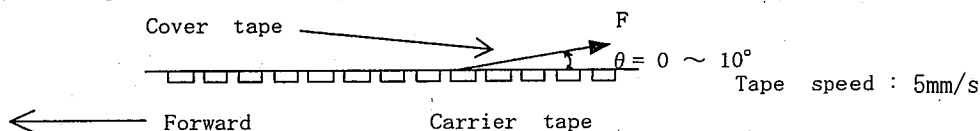

(3) Tape strength against bending:

The radius of bending circle should be 30mm or more.

If it is less than 30mm, the cover may peel.

(4) Jointing of tape: There should not be joint of cover tape or carrier tape.

(5) Quantity per reel Average 800pcs. per reel

(6) Packing mass: 800g(One packing/Reference)

(7) Product mass: Approximately 0.06g(One product/Reference)

(8) Others:

- ① There is no products stuffed such as an upside-down products or defect products.
- ② There is no continuous empty pockets.
- ③ Products should be easily taken out.
- ④ Products should not be attached to the cover tape at peeling.

6-2. Packing specification

6-2-1. Moisture proof package

In order to avoid the absorption of humidity while transport and storage, the devices are kept in moisture proof aluminum package.

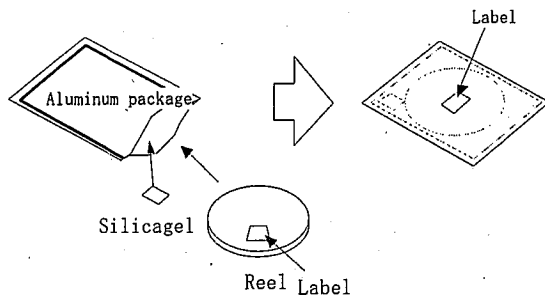

6-2-2. Storage conditions

Temperature : 5 to 30°C Humidity : less than 60%RH

6-2-3. Handling method after opening

(1) Please keep the devices under the following conditions after opening the packages, and make a soldering within 3 days.

Temperature : 5 to 30°C Humidity : less than 60%RH

(2) In case the devices are not used for a long time after opening, the storage in a dry box is recommended. Or it is better to repack the devices with a desiccative by the sealer and put them in the some storage conditions as 6-2-2.

(3) Please make a soldering after a following baking treatment if unused term should be over the conditions of (2)

*Recommended conditions:

- ① in taping
Temperature: 95°C to 100°C, Time: 16 hours to 42 hours
- ② in individual (on PWB or metallic tray)
Temperature: 100°C to 120°C, Time: 12 hours to 15 hours

Please note that distortion of the reel etc. might be caused or with the products piled up or stressed while baking process.

Please confirm that the product is cooled to the room temperature after the baking.

SHARP

6-3. Label

SHARP CORPORATION	
PART No.	GM4WA25300A
QUANTITY	800
[]	
[]	
LOT No.MI07A01 RANK ○ (EIAJ C-3) MADE IN PHILIPPINE	

← Model number
← Quantity of products

← EIAJ C-3 Bar code
← EIAJ C-3 Bar code

← LOT number and Chromaticity rank
← Production country

1) Lot Number

M I 0 7 A 0 1
① ② ③ ④ ⑤

- ① Production plant code(to be alphabet)
- ② Auxiliary code
- ③ Year of production(the last two figures of the year)
- ④ Month of production
(indicated with alphabet,January corresponding to A)
- ⑤ Date of production(01~31)

2) Rank

○

○:Chromaticity



6-4. Chromaticity rank (*1)

6-4-1 chromaticity rank table(*1)

(Tc=25 °C)

chromaticity rank	chromaticity (x,y)								condition
	point1		point2		point3		point4		
	x	y	x	y	x	y	x	y	
a	0.275	0.343	0.300	0.350	0.275	0.318	0.300	0.325	R: I _F =(21)mA G: I _F =(25)mA B: I _F =(7)mA
b	0.300	0.350	0.325	0.356	0.300	0.325	0.325	0.331	
c	0.250	0.312	0.275	0.318	0.250	0.287	0.275	0.293	
d	0.275	0.318	0.300	0.325	0.275	0.293	0.300	0.300	
e	0.300	0.325	0.325	0.331	0.300	0.300	0.325	0.306	
f	0.325	0.331	0.350	0.338	0.325	0.306	0.350	0.313	
g	0.250	0.287	0.275	0.293	0.250	0.262	0.275	0.268	
h	0.275	0.293	0.300	0.300	0.275	0.268	0.300	0.275	
i	0.300	0.300	0.325	0.306	0.300	0.275	0.325	0.281	
j	0.325	0.306	0.350	0.313	0.325	0.281	0.350	0.288	
k	0.275	0.268	0.300	0.275	0.275	0.243	0.300	0.250	
l	0.300	0.275	0.325	0.281	0.300	0.250	0.325	0.256	

(Tolerance : x,y:±0.02)

6-4-2 chromaticity rank graph

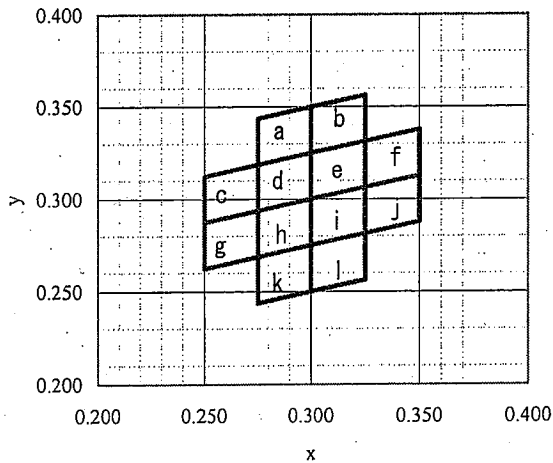

[Note]

- 1) Chromaticity ranks above are not guaranteed data measured under the condition in the table.
- 2) Shipment to be conducted without regard to rank ratio.
- 3) To use mixed color, adjust current of each color within power dissipation.

6-5. Environment

6-5-1. Ozone Depleting Substances.

- (1) The device doesn't contain the following Ozone Depleting Substances.
- (2) The device doesn't have a production line whose process requires the following substances.
Restricted substances : CFCs, halones, CCl₄, 1-1-1 Trichloroethane(Methylchloroform)

6-5-2 Brominated Flame Retardants

The device doesn't contain Brominated Flame Retardants (PBBOs,PBBs).

SHARP

7. Precautions for use

7-1. General description for use

- (1) In designing a circuit, please make sure not to give reverse voltage to the LEDs at any time.
- (2) Since the LEDs are very small, they are easily damaged by external stress.
Please make sure that no shock is given to the LEDs after assembling.
- (3) Please don't look straight for a long time at the LEDs under High power operation, which may damage your eyes.
- (4) The LEDs can be damaged by static electricity or surge voltage. Please equip yourself with a wrist band or anti-electricity-gloves in handling the LEDs.
Also, make sure that all the devices and equipments must be grounded.
- (5) Avoid locating other heat sources (ex. motor, etc.) near the LEDs on the circuit board.
Those heat sources will damage the devices.
Please design the circuit board so that case temperature is always kept under 85°C including the self-heating. (when the LEDs are turned on)
- (6) Since dust on the surface of the luminescence parts is hard to take off and may cause to weaken luminous intensity level, please handle the LEDs in a clean, non-dusty condition.
Moreover, the LEDs can be damaged or broken, if collets of mounting machine add excessive stress to the resin parts, therefore, please handle the products with confirmation of the mounting conditions.
- (7) Please pay attention not to add any external stress or force to luminescent resin parts after mounting as well.
- (8) The products are not designed for the use under any of the following conditions.
Please confirm their performance and reliability well enough if you use under any of the following conditions;
 - (1) In a place with a lot of moisture, dew condensation, briny air, and corrosive gas (Cl, H₂S, NH₃, SO₂, NO_x, etc.).
 - (2) Under the direct sunlight, outdoor exposure, and in a dusty place.
 - (3) In water, oil, medical fluid, and organic solvent.

SHARP

7-2. Soldering

7-2-1. Reflow soldering

- (1) It is not recommended to exceed the soldering temperature and time shown below.
Caused by substrate bend or the other mechanical stress during reflow soldering may happen gold wire disconnection etc. Therefore please check and study your solder reflow machine's best condition.
- (2) Give the soldering process as soon as possible after opening the aluminum packages.
In case of giving reflow process twice, the second reflow process should be given within 3 days after the first one. (Storage condition ; at 30°C, RH less than 60%RH)
- (3) This device is not designed for the dip soldering.
- (4) Reflow soldering temperature profile
Use under the conditions shown figure below.
(After reflow soldering, rapid cooling should be avoided.)

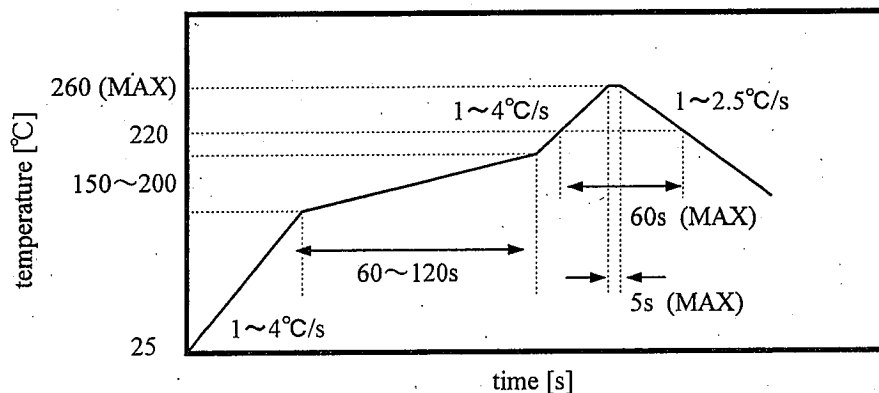

Fig. Reflow soldering temperature profile

As for Reflow Soldering Temperature Profile, in order to maintain the products quality, it is recommended that the peak temperature should be lower, and cool down should be taken longer, and that the gradient of cooling down temperature should be as low as possible. Moreover, since the thermal conduction to the LEDs depends on the specification of the reflow machine, and the size and layout of the PWBs, please take a careful look at by your own evaluation. Nitrogen reflow is also available for the products.

- (5) Basically, give the reflow process only once. In the case 2nd reflow is required and unavoidable the 2nd one should be given soon after the 1st one.
Especially in case that there is a water-washing process or a solvent-washing process after the 1st-reflow, please dry each product under the condition of page.12 6-2-3(3), before the 2nd reflow.

SHARP

(6) In case that the PWB backside is designed to be dipped, the heat or the warp of the PWB is likely to cause mechanical stress. To relieve the stress, the reflow for the product should be after dipping.

(7) The electrode parts have silver plated on. If they are exposed to the air with corrosive gas etc., the plated surface would be damaged, which may affect soldering.

Please pay attention to the storage condition, and avoid the long-term storage.

7-2-2. Recommended solder pattern

(1) Metal mask that is 0.2mm to 0.3mm thick is recommended for screen printing.

Solder ability depends on the reflow condition, solder paste and materials of the PWBs etc.

Please check and study your actual condition before use.

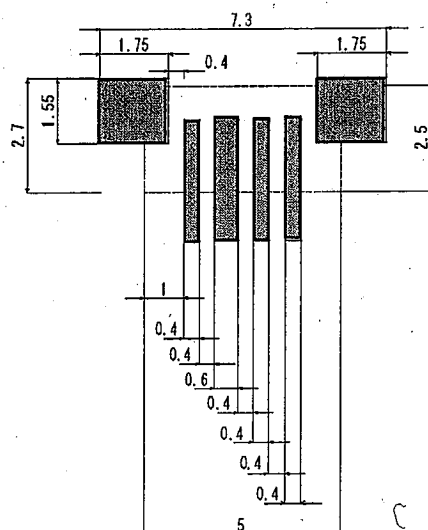

7-3. For cleaning

Basically, please use the soldering paste without need of cleaning.

If the PWB needs cleaning, please follow the recommended conditions of ultrasonic cleaning.

① Recommended Conditions: R.T. 40kHz, 30W/l, 3 to 4 minutes

② Recommended Solvents: water, ethyl alcohol, isopropyl alcohol

The affect on the device depends on the conditions such as the size of ultrasonic bath, ultrasonic output, duration, the size of PWB and device mounting method.

Test the cleaning method under the actual conditions and check for abnormalities before actual use.